

Ulisses

Design by Angelo Pinaffo





- ① Piano disponibile in diverse misure e forme.
- ② Gancio in nylon grigio per unione piani (2 per tavolo, optional).
- ③ Meccanismo di ribaltamento in lamiera d'acciaio con maniglie di sblocco. Cover in polipropilene (PP) nero.
- ④ Ruota girevole con freno (kick pedal) Ø 75 mm con supporto in poliammide e gomma termoplastica anti-traccia.
- ⑤ Disponibili diversi contenitori in acciaio e alluminio con moduli elettrici e/o multimediali. Disponibile con modulo passacavi (optional).
- ⑥ Passacavi orizzontale in polipropilene (PP) nero.
- ⑦ Gamba con montante in tubo d'acciaio rettangolare 80x60 mm con piede in alluminio pressofuso. Verniciatura epossipoliestere a polveri.

- ① Table top available in different sizes and shapes.
- ② Grey nylon linking device to join tabletops (2 per table, optional).
- ③ Steel sheet metal flip top mechanism with release handles. Cover in black polypropylene (PP).
- ④ Swivel castor with pedal brake Ø 75 mm, polyamide support and thermoplastic rubber.
- ⑤ Several steel and aluminum containers available, with electrical and/or multimedia modules. Available with cable management module (optional).
- ⑥ Black polypropylene cable management system (PP).
- ⑦ Leg with rectangular steel tube column 80x60 mm with diecast aluminium foot. Epoxy powder painting.

- ① Plateau disponible en différentes tailles et formes.
- ② Crochet en nylon gris pour union des plateaux (2 par table, optionnel).
- ③ Mécanisme de basculement en tôle d'acier avec poignées déverrouillage. Cover en polypropylène (PP) noir.
- ④ Roulette pivotante avec frein (kick-pedal) Ø 75 mm avec support en polyamide et caoutchouc thermoplastique anti-trace.
- ⑤ Divers conteneurs en acier et en aluminium disponibles avec modules électriques et/ou multimédia. Disponible avec module passe-câbles (optionnel).
- ⑥ Passe-câbles horizontale en polypropylène (PP) noir.
- ⑦ Piètement avec tube montant rectangulaire en acier 80x60 mm avec pied en aluminium brossé. Vernis en poudre époxy-polyester.



Pannello frontale (optional).

Finiture:
Melaminico
Melaminico 3D
MDF Perfect Sense.

Modesty panel (optional).

Finishes:
Melamine
MFC 3D
MDF Perfect Sense.

Voile de fond (optionnel).

Finitions:
Mélaminé
Mélaminé 3D
MDF Perfect Sense.



Gamba con in tubo d'acciaio rettangolare 80x60 mm con piede in alluminio pressofuso. Verniciatura epossipoliestere a polveri.

6 Finiture:
Montante Nero
Piede Nero

Montante Grigio
Piede Grigio

Montante Bianco
Piede Bianco

Montante Nero
Piede in alluminio spazzolato lucido

Montante Grigio
Piede in alluminio spazzolato lucido

Montante Bianco
Piede in alluminio spazzolato lucido

Leg with rectangular steel tube column 80x60 mm with diecast aluminium foot. Epoxy powder painting.

6 Finishes:
Column Black
Foot Black

Column Grey
Foot Grey

Column White
Foot White

Column Black
Diecast aluminium polished foot

Column Grey
Diecast aluminium polished foot

Column White
Diecast aluminium polished foot

Pied en tube d'acier rectangulaire 80x60 mm avec pied en aluminium moulé. Vernis en poudre époxy-polyester.

6 Finitions:
Colonne Noire
Pied Noir

Colonne Grise
Pied Gris

Colonne Blanche
Pied Blanc

Colonne Noire
Pied en aluminium brossé brillant

Colonne Grise
Pied en aluminium brossé brillant

Colonne Blanche
Pied en aluminium brossé brillant



KIT14

Coppia piedi compensatori in alluminio spazzolato con piedini neri.

KIT14

Pair of compensator feet in brushed aluminum with black feet.

KIT14

Paire de pieds compensateurs en aluminium brossé avec pieds noirs.



Gancio in nylon grigio per unione piani per piani con angoli dritti 90°.

Grey nylon linking device to join tabletops with straight corners 90°.

Crochet en nylon gris pour union des plateaux (2 par table).

AGG10

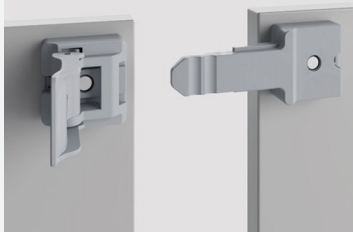
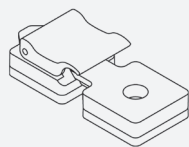

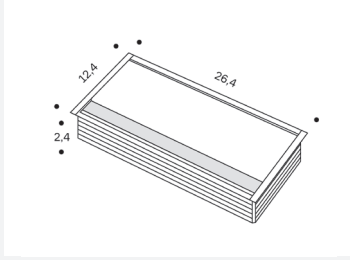

BOX07_A

Contenitore passacavi richiudibile in alluminio verniciato (Bianco RAL 9003, Nero RAL 9005, Grigio RAL 9006) con vassoio in lamiera zincata per la gestione dei cavi.

BOX07_A

Resealable aluminum painted cable management (White RAL 9003, Black RAL 9005 or Grey RAL 9006) with galvanized sheet metal tray for cable.

BOX07_A

Boîte refermable en aluminium verni pour passage câbles (Blanc RAL 9003, Noir RAL 9005 ou Gris RAL 9006) avec conteneur en tôle de zinc pour la gestion de les câbles.

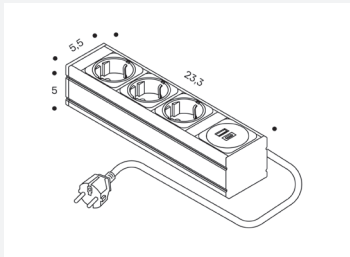
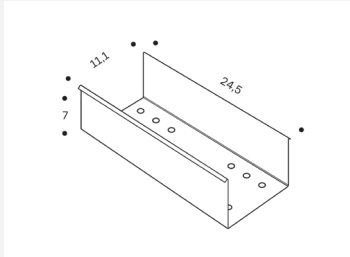

BOX08

Modulo multipresa in alluminio verniciato Nero RAL 9005, con cavo di alimentazione 2 m con spina maschio schuko.

BOX08

Multi-socket module in painted aluminum Black RAL 9005, with 2 m power cable with male Schuko plug.

BOX08

Module multiprise en aluminium verni Noir RAL 9005, avec câble d'alimentation de 2 m avec fiche Schuko mâle.

Prese elettriche

Sockets

Prises electriques



Schuko

Multimedia

Multimedia

Multimedia



USB
charger
(Type A+C)



HDMI



RJ45
(CAT6)

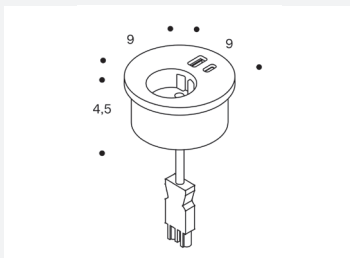

BOX09_A

Modulo singolo in tecnopolimero Nero con cover colorata* : 1x presa Schuko + 1x double USB charger (Type A+C). Versione da incasso, cavo di alimentazione con connettore GST18.

BOX09_A

Single module in Black technopolymer with colored cover* : 1x Schuko socket + 1x double USB charger (Type A+C). Built-in version, power cable with GST18 connector.

BOX09_A

Module unique en technopolymère Noir avec couvercle coloré* : 1x Schuko prise + 1x double USB charger (Type A+C). Version intégrée, câble d'alimentation avec connecteur GST18.

Prese elettriche
Sockets
Prises electriques



Schuko



Schuko
France

Finiture Cover

Nero RAL 9005
Bianco RAL 9003
Verde PANTONE 5615C
Azzurro RAL 5014
Giallo RAL 1012

Cover Finishes

Black RAL 9005
White RAL 9003
Green PANTONE 5615C
Light blue RAL 5014
Yellow RAL 1012

Finitions Couvercle

Noir RAL 9005
Blanc RAL 9003
Vert PANTONE 5615C
Bleu Ciel RAL 5014
Jaune RAL 1012

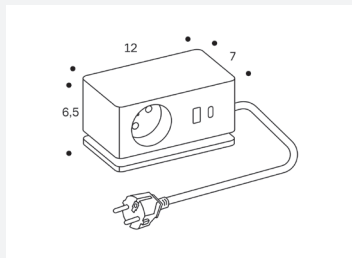

BOX10_A

Modulo singolo in tecnopolimero Nero o Bianco: 1x presa Schuko + 1x double USB charger (Type A+C). Versione con base in metallo, cavo di alimentazione 2 m con spina maschio schuko. Base rimovibile per fissaggio sotto piano.

BOX10_A

Single module in Black or White technopolymer: 1x Schuko socket + 1x double USB charger (Type A+C). Metal base version, 2 m power cable with male Schuko plug. Removable base for undertop fixing.

BOX10_A

Module unique en technopolymère Noir ou Blanc: 1x Schuko prise + 1x double USB charger (Type A+C). Version avec base en métal, câble d'alimentation de 2 m avec prise Schuko mâle. Base amovible pour fixation sous le plateau.

Prese elettriche
Sockets
Prises electriques



Schuko

Schuko
France

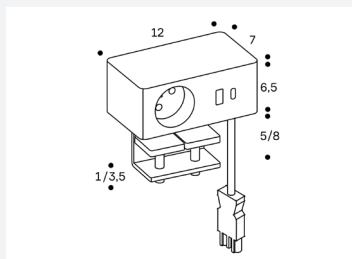

BOX10_B

Modulo singolo in tecnopolimero Nero o Bianco: 1x presa Schuko + 1x double USB charger (Type A+C). Versione con morsetti, cavo di alimentazione con connettore GST18.

BOX10_B

Single module in Black or White technopolymer: 1x Schuko socket + 1x double USB charger (Type A+C). Version with terminal block, power cable with GST18 connector.

BOX10_B

Module unique en technopolymère Noir ou Blanc: 1x Schuko prise + 1x double USB charger (Type A+C). Version avec bornier, câble d'alimentation avec connecteur GST18.

Prese elettriche
Sockets
Prises electriques



Schuko

Schuko
France

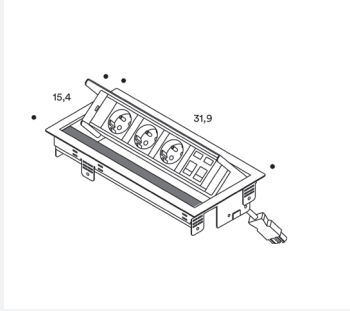

BOX02_B

Contenitore richiudibile in acciaio verniciato.

Finiture

Bianco RAL 9016
Nero RAL 9017
Grigio RAL 9006

Versioni standard*

3x prese elettriche uguali + 2x RJ45

3x prese elettriche uguali + 1x Double USB charger (Type A+C)

* Per composizioni diverse chiedere un preventivo.

Prese elettriche

BOX02_B

Resealable painted steel box.

Finishes

White RAL 9016
Black RAL 9017
Grey RAL 9006

Standard versions*

3x same sockets - 2x RJ45

3x same sockets + 1x Double USB charger (Type A+C)

* For different compositions request a quotation.

Sockets

BOX02_B

Boîte en acier verni.

Finitions

Blanche RAL 9016
Noire RAL 9017
Grise RAL 9006

Version standard*

3 x mêmes prises électriques - 2xRJ45.

3x mêmes prises électriques + 1x Double USB charger (Type A+C)

* Pour des compositions différentes demander un devis.

Prises électriques



Multimedia

Multimedia

Multimedia

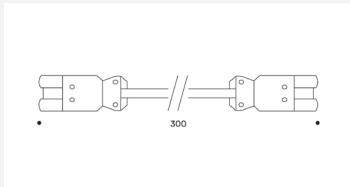
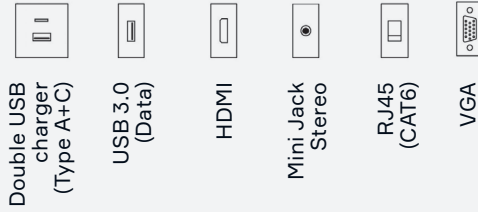

CONNECTION CABLE

Cavo di connessione tra moduli elettrici 1-2-3 mt (H05W-F 3G 1.5 mm² / GST18-GST18).

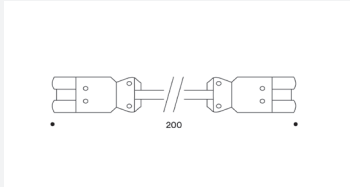

CONNECTION CABLE

Connection cable to joint variable plug power supply system 1-2-3 mt (H05W-F 3G 1.5 mm² / GST18-GST18).

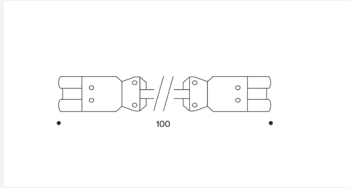

CONNECTION CABLE

Câble de connexion entre éléments électriques 1-2-3mt (H05W-F 3G 1.5 mm² / GST18-GST18).

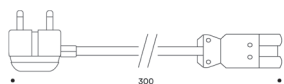

ELECTRIC CABLE

Cavo elettrico 2-3 mt
(H05VV-F 3G 1.5 mm² /
GST18-Spina Maschio).

ELECTRIC CABLE

Electric cable 2-3 mt
(H05VV-F 3G 1.5 mm² /
GST18-Male Plug).

ELECTRIC CABLE

Câble électrique 2-3 mt
(H05W-F 3G 1.5 mm² /
GST18-Prise mâle).

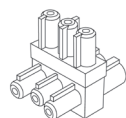
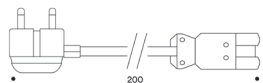

CAV_015

Distributore a 3 vie
(Maschio/Maschio/
Femmina).

CAV_015

Power distributor with
3 (Male/Male/Female).

CAV_015

Distributeur à 3 voies
(Mâle/Mâle/Femelle).

Finiture

Finishes / Finitions

FINITURE PIANO

TABLE TOP FINISHES

FINITIONS PLATEAU

Truciolare rivestito Melaminico sp. 25 mm / MFC thk. 25 mm /
Aggloméré revêtu en Méla miné ép. 25 mm

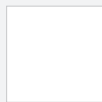

U12
Bianco
White
Blanc

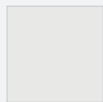

0FP
Grigio
Grey
Gris

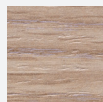

0ON
Rovere chiaro
Light Oak
Chêne Clair

Truciolare rivestito Melaminico sp. 18 mm (FSC®) / MFC thk. 18 mm (FSC®) /
Aggloméré revêtu en Méla miné ép. 18 mm (FSC®)

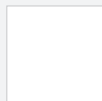

U12
Bianco
White
Blanc

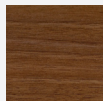

AS5
Noce Kiro s
Walnut Kiro s
Noyer Kiro s

Truciolare rivestito Melaminico 3D sp. 22 mm / MFC 3D thk. 22 mm /
Aggloméré revêtu en Méla miné 3D ép. 22 mm

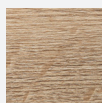

ST37
Rovere Nat
Oak Nat
Chêne Nat

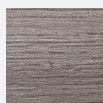

S075
Quercia Grigia
Grey Oak
Chêne Gris



S074
Quercia Bianca
White Oak
Chêne Blanc

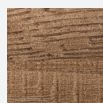

S073
Quercia Miele
Honey Oak
Chêne Miel

MDF laccato Perfect Sense sp. 22 mm / Lacquered MDF Perfect Sense thk. 22 mm /
MDF laqué Perfect Sense ép. 22 mm



U999
Nero
Black
Noir

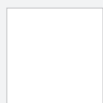

W1100
Bianco
White
Blanc



U727
Stone Grey



U961
Graphite Grey



U604
Reed Green

Truciolare rivestito Laminato Scrivibile sp. 20 mm [Solo per Ulisses 160AR]
Chipboard covered in Writable Laminate thk. 20 mm [Only for Ulisses 160AR]
Aggloméré revêtu en Stratifié inscriptible ép. 20 mm [Seulement pour Ulisses 160AR]

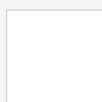

028
Bianco
White
Blanc

*

Per il top con Laminato scrivibile non sono disponibili i BOX elettrici
Electrical BOX not available with writable Laminate top
Les BOX électriques ne sont pas disponibles pour les plateaux en Stratifié inscriptible

FINITURE GAMBE

Verniciato / Painted / Verni

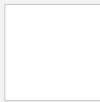

RAL 9003
Bianco
White
Blanc



RAL 9006
Grigio
Grey
Gris



RAL 9005
Nero
Black
Noir

LEG FINISHES

FINITIONS PIETEMENTS

Piede / feet / Pied

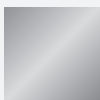

Alluminio spazzolato
Polished aluminum
Aluminium brossé

Dimensioni Piano

Top Dimensions / Dimension du plateau

ULISSES 80AQ**

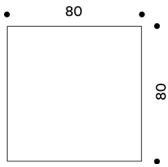

ULISSES 120AR**

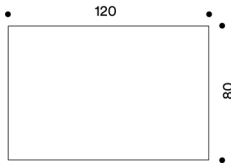

ULISSES 140AR**

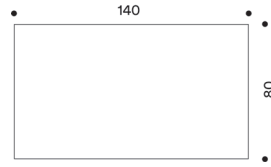

ULISSES 160AR**

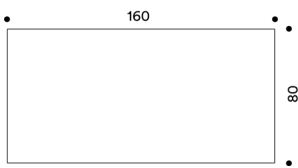

ULISSES 180AR**

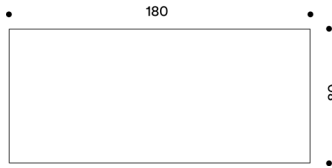

ULISSES 200AR**

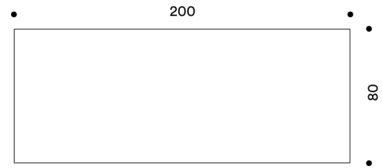

ULISSES 180AN**

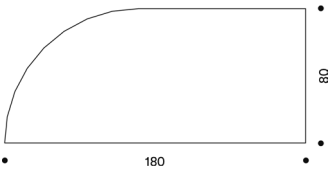

ULISSES 180AD**

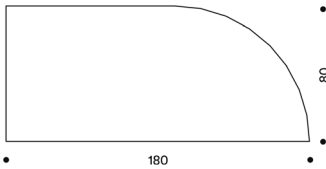

ULISSES 160AV**

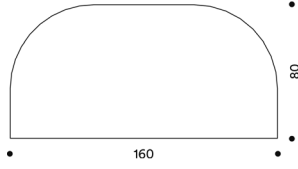

ULISSES 180AV**

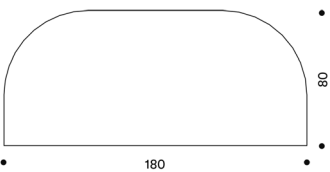

ULISSES 120AB**

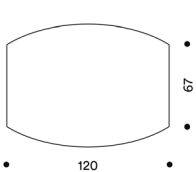

ULISSES 184AB**

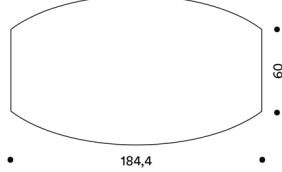

ULISSES 160AL**

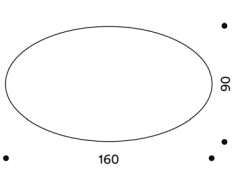

ULISSES 200AL**

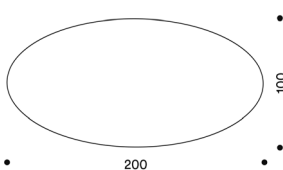

ULISSES 220AL**

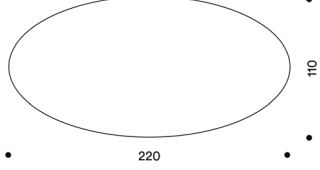

ULISSES 160AP**

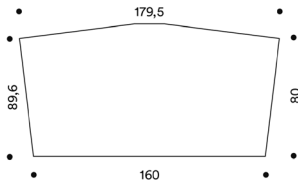

Dimensioni Modesty

Modesty Dimensions / Voile de fond

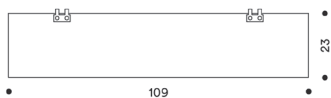

MD120

Per tavolo lunghezza 120 cm

For table 120 cm long

Pour table longueur 120 cm

Für Tischbreite 120 cm

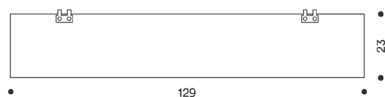

MD140

Per tavolo lunghezza 140 cm

For table 140 cm long

Pour table longueur 140 cm

Für Tischbreite 140 cm



MD160

Per tavolo lunghezza 160 cm

For table 160 cm long

Pour table longueur 160 cm

Für Tischbreite 160 cm

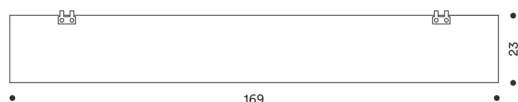

MD180

Per tavolo lunghezza 180 cm

For table 180 cm long

Pour table longueur 180 cm

Für Tischbreite 180 cm



MD200

Per tavolo lunghezza 200 cm

For table 200 cm long

Pour table longueur 200 cm

Für Tischbreite 200 cm

Disegni Tecnici

Technical Drawings / Dessins Technique

ULISSES

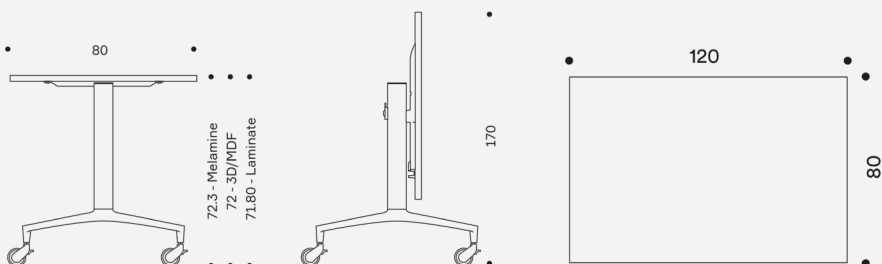

Composizioni

Compositions / Compositions

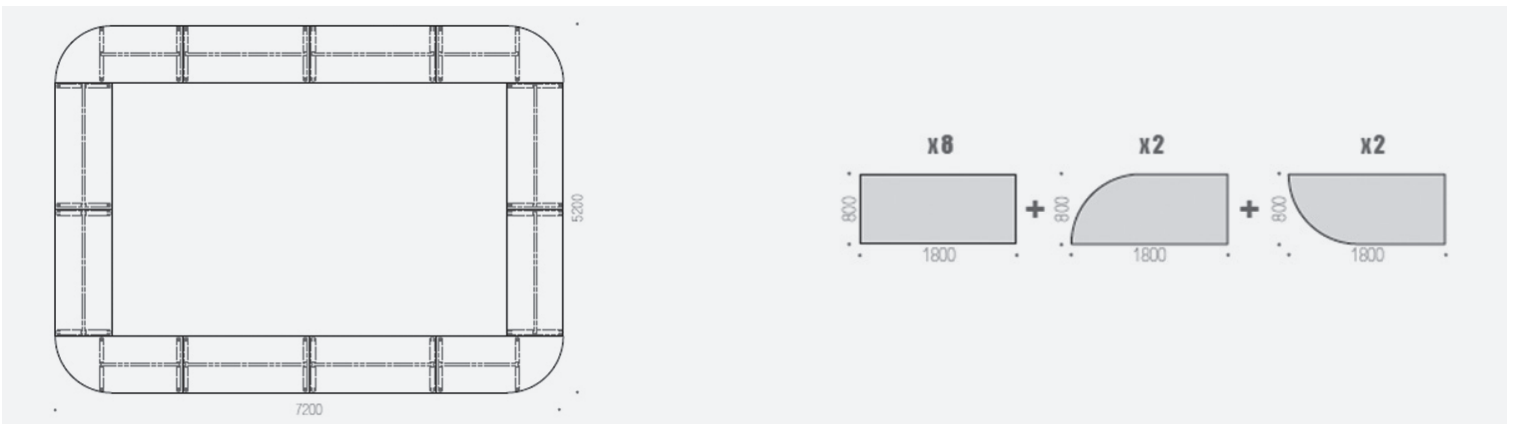
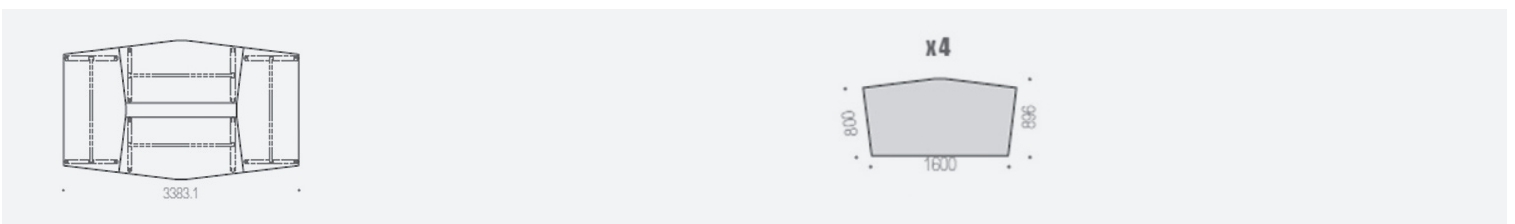
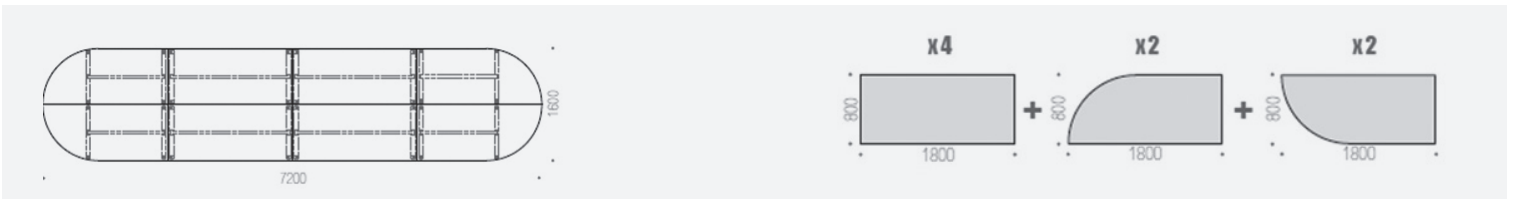
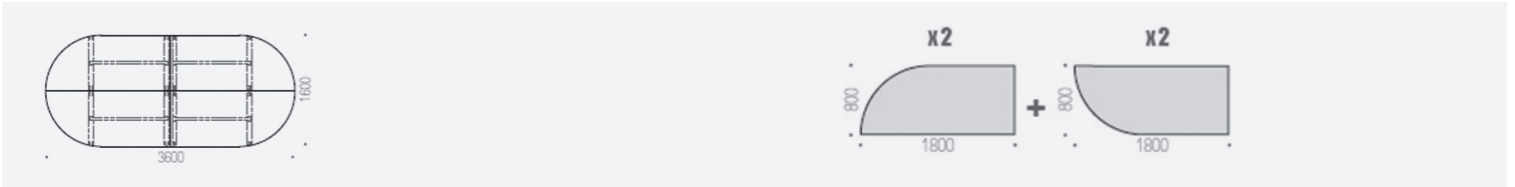
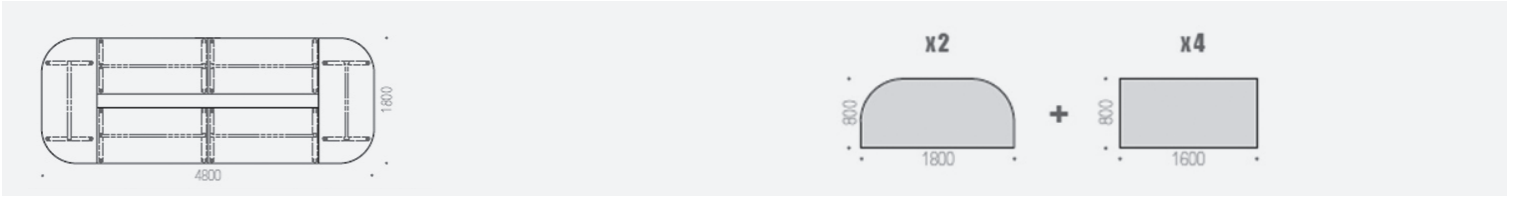

Sostenibilità

Sustainability / Durabilité

PARTI METALLICHE

In conformità alla Direttiva 2011/617/UE sulla registrazione dell'uso di determinate sostanze pericolose nelle apparecchiature elettriche ed elettroniche (ROHS II), Direttiva delegata 2015/863/UE recante modifica dell'allegato II della Direttiva 2011/65/UE per quanto riguarda l'elenco delle sostanze con restrizioni d'uso (ROHS III) e Regolamento CE 1907/2006 concernente la registrazione, la valutazione, l'autorizzazione e la restrizione delle sostanze chimiche (REACH).

PARTI VERNICIATE

In conformità alla norma EN ISO 11890-2:2013, Pitture e vernici - determinazione del contenuto di composti organici volatili (VOC) - Parte 2.

IMBALLI

Provenienti da fornitori certificati che utilizzano materiali reperiti in modo responsabile.

RICICLABILITÀ DEL PRODOTTO

Una volta dismesso il prodotto non deve essere disperso nell'ambiente. Prodotto riciclabile separando i componenti.

METAL PARTS

Certification of compliance in accordance with Directive 2011/617/UE on the restriction of the use of certain hazardous substances in electrical and electronic equipment (ROHS II), delegated Directive 2015/863/UE amending Annex II to Directive 2011/65/UE concerning the list of restricted substances (ROHS III) and Regulation No 1097/2006 concerning the Registration, Evaluation, Authorisation and Restriction of Chemicals (REACH).

PAINTED PARTS

Certification of compliance in accordance with EN ISO 11890-2:2013, Paints and varnishes - Determination of volatile organic compound (VOC) content — Part 2

PACKAGING

From suppliers certified who use responsibly sourced materials.

RECYCLING OF THE PRODUCT

Once decommissioned, avoid release into the environments. Recyclable product separating its components.

PIÈCES MÉTALLIQUES

Conformément à la directive 2011/617/UE sur l'enregistrement de l'utilisation de certaines substances dangereuses dans les équipements électriques et électroniques (ROHS II), directive déléguée 2015/863/UE modifiant l'annexe II de la directive 2011/65/UE en ce qui concerne la liste des substances soumises à restrictions d'utilisation (ROHS III) et règlement CE 1907/2006 concernant l'enregistrement, l'évaluation, l'autorisation et la restriction des substances chimiques (REACH).

PARTI VERNIS

Conformément à la norme EN ISO 11890-2:2013, Peintures et vernis - détermination de la teneur en composés organiques volatils (COV) - Partie 2.

EMBALLAGES

De fournisseurs certifiés qui utilisent des matériaux provenant de sources responsables.

RECYCLABILITÉ DU PRODUIT

Une fois le produit retiré, il ne doit pas être dispersé dans l'environnement. Produit recyclable en séparant les composants.

Note

Notes / Note

Pulizia

Per le parti metalliche consigliamo esclusivamente un panno morbido e alcool asciugando bene dopo la pulizia. Per le superfici in plastica, usare panno umido ed acqua con detersivo liquido neutro, non usare solventi, trielina, acetone o ammoniaca.

Cleaning

For the metal parts we recommend only a soft cloth and alcohol, drying well after cleaning. For plastic surfaces, use a damp cloth and water with neutral liquid detergent, do not use solvents, trichlorethylene, acetone or ammonia.

Nettoyage

Pour les parties métalliques, nous recommandons uniquement un chiffon doux et de l'alcool, bien sécher après le nettoyage. Pour les surfaces en plastique, utilisez un chiffon humide et de l'eau avec un détergent liquide neutre, n'utilisez pas de solvants, de trichloréthylène, d'acétone ou d'ammoniac.

Garanzia

I nostri prodotti sono garantiti 5 anni (testo integrale della garanzia su richiesta). Un uso improprio del prodotto preclude la garanzia dello stesso.

Warranty

Our products are guaranteed for 5 years (full text of the guarantee on request). Improper use of the product precludes its warranty.

Garantie

Nos produits sont garantis 5 ans (texte complet de la garantie sur demande). Une mauvaise utilisation du produit exclut sa garantie.

Uso improprio

Non sono consentiti: Modifiche strutturali e/o manomissioni al prodotto.

Improper use

The following are not allowed: Structural changes and / or product tampering.

Utilisation incorrecte

Les éléments suivants ne sont pas autorisés : Modifications structurelles et/ou altération du produit.