

Joi

Design by IBEBI Lab

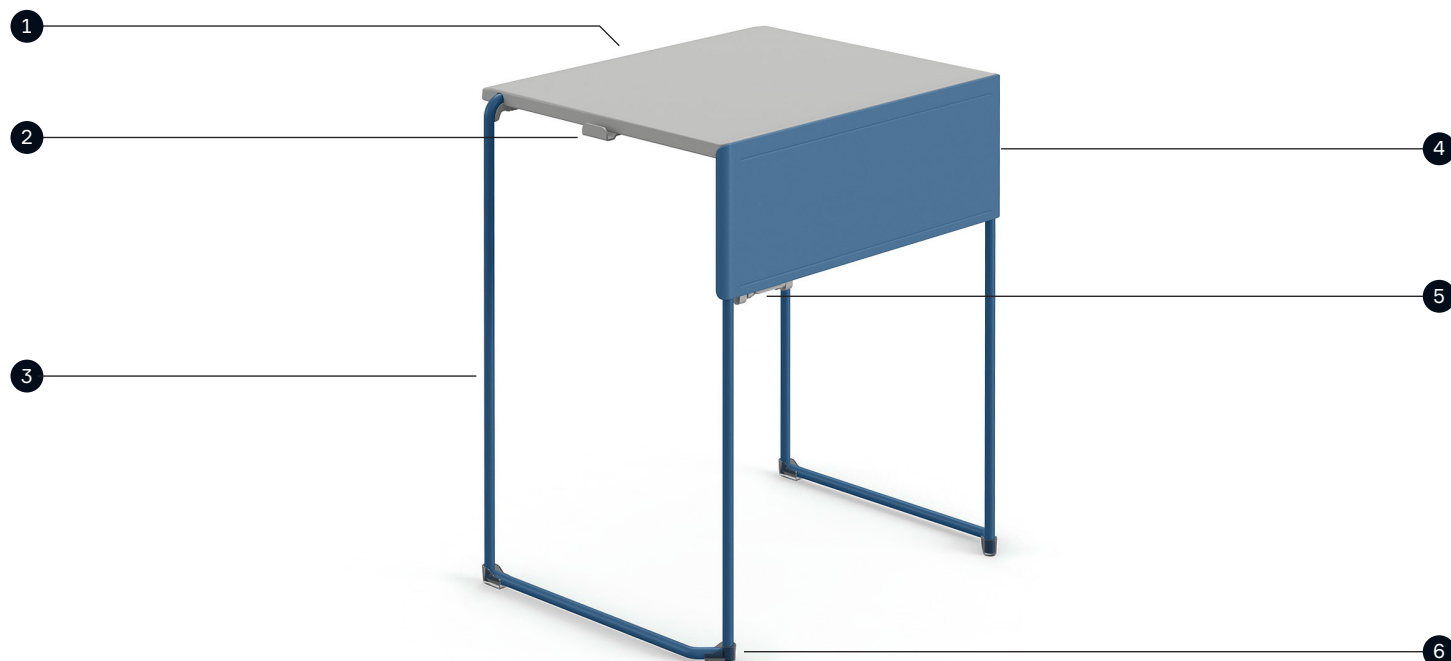



① Piano in ABS o Melaminico FSC®.

② Porta borse / Gancio per unione tavoli laterale.

③ Struttura in tubo d'acciaio Ø 16 mm. Verniciatura epossipoliestere a polveri.

④ Pannello frontale in ABS.

⑤ Gancio in polipropilene (PP) per unione tavoli frontale (optional).

⑥ Piedino in capoliestere di polietilene tereftalato trasparente (PETG).

① ABS or MFC FSC® top.

② Bag hook / Side joining hook.

③ Steel tube frame Ø 16 mm. Epoxy powder painting.

④ ABS front panel.

⑤ Front joining hook in polypropylene (PP) (optional).

⑥ Saddle feet in polyethylene terephthalate (PETG).

① Plateau en ABS ou Melamine FSC®.

② Crochets porte sac/ Crochet de connexion lateral.

③ Structure en tube d'acier Ø 16 mm. Vernis en poudre epoxy polyester.

④ Panneau avant en ABS.

⑤ Crochet de connexion frontal en polypropylene (PP) (optionnel).

⑥ Embout en capoliester tereftalato transparent en polyethylene (PETG).

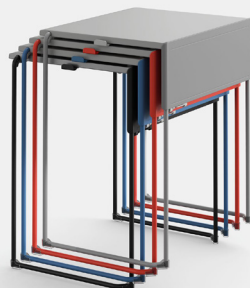

Impilabile fino a 10 tavoli.
Stackable up to 10 tables.
Empilable jusqu'à 10 tables.



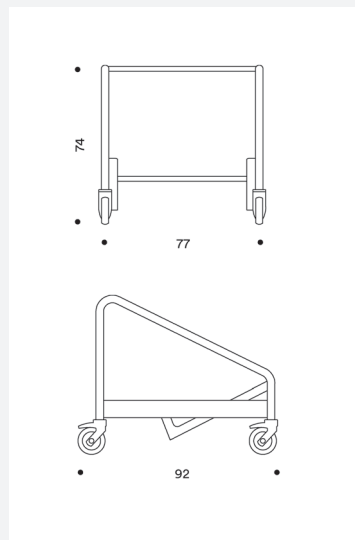

GALILEO CARR

Carrello porta tavoli in tubo d'acciaio nero (max 20 tavoli).

GALILEO CARR

Black steel tube frame trolley-tables (max 20 tables).

GALILEO CARR

Chariot porte tables en tube d'acier noir (max 20 tables).

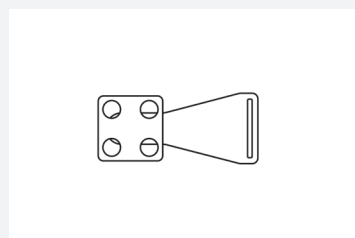

JOI 01

Gancio di unione laterale in metallo verniciato Grigio RAL 9006.

JOI 01

Side joining hook in Grey RAL 9006 painted steel.

JOI 01

Crochet de connexion latéral en acier verni Gris RAL 9006.

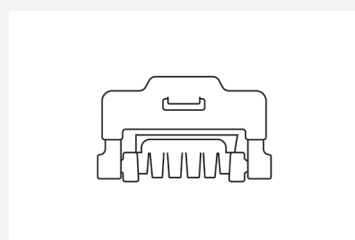

JOI 02

Gancio di unione frontale in polipropilene Grigio RAL 9006.

JOI 02

Front joining hook in Grey RAL 9006 polypropylene.

JOI 02

Crochet de connexion frontal en polypropylène Gris RAL 9006.

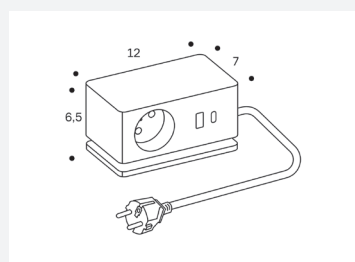

BOX10_A

Modulo singolo in tecnopolimero Nero o Bianco: 1x presa Schuko + 1x double USB charger (Type A+C). Versione con base in metallo, cavo di alimentazione 2 m con spina maschio schuko. Base rimovibile per fissaggio sotto piano.

BOX10_A

Single module in Black or White technopolymer: 1x Schuko socket + 1x double USB charger (Type A+C). Metal base version, 2 m power cable with male Schuko plug. Removable base for undertop fixing.

BOX10_A

Module unique en technopolymère Noir ou Blanc: 1x Schuko prise + 1x double USB charger (Type A+C). Version avec base en métal, câble d'alimentation de 2 m avec prise Schuko mâle. Base amovible pour fixation sous le plateau.

Prese elettriche
Sockets
Prises electriques



Schuko

Schuko
France

Finiture

Finishes / Finitions

**FINITURE
PIANO****TABLE TOP
FINISHES****FINITIONS
PLATEAU**

Truciolare rivestito Melaminico sp. 18 mm / MFC thk. 18 mm /
Agglomeré revêtu en Méla miné ép. 18 mm



U12
Bianco
White
Blanc

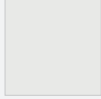

0FP
Grigio
Grey
Gris

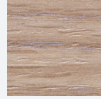

0ON
Rovere chiaro
Light Oak
Chêne Clair

Truciolare rivestito Melaminico sp. 18 mm (FSC®) / MFC thk. 18 mm (FSC®) /
Agglomeré revêtu en Méla miné ép. 18 mm (FSC®)



U12
Bianco
White
Blanc

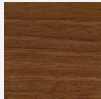

AS5
Noce Kiros
Walnut Kiros
Noyer Kiros

ABS

9006
Grigio
Grey
Gris

**FINITURE PANNELLO
FRONTALE (ABS) e
STRUTTURA (Verniciato)****FRONT PANEL (ABS) and
FRAME (Painted) FINISHES****FINITIONS PANNEAU
FRONTAL (ABS) et
STRUCTURE (Verni)**

RAL 9005
Nero
Black
Noir



RAL 9006
Grigio
Grey
Gris



RAL 5023
Blu
Blue
Bleu



RAL 3000
Rosso
Red
Rouge

Disegni Tecnici

Technical Drawings / Dessins Technique

JOI

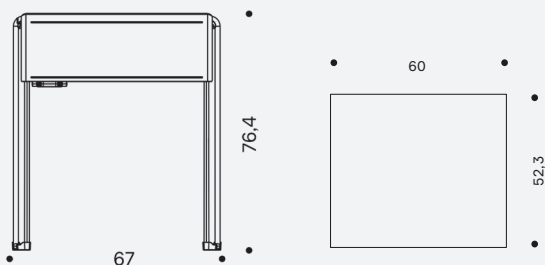

JOI T3

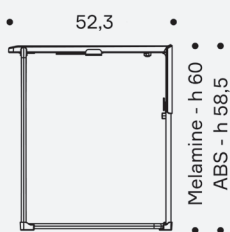

Melamine - h 60
ABS - h 58,5

JOI T4

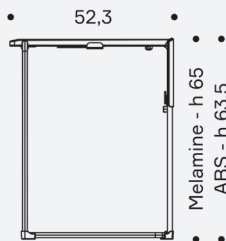

Melamine - h 65
ABS - h 63,5

JOI T5

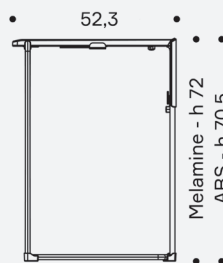

Melamine - h 72
ABS - h 70,5

JOI T6

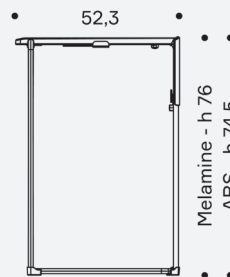

Melamine - h 76
ABS - h 74,5

Sostenibilità

Sustainability / Durabilité

Prodotto	Unità minima di riferimento, e relativa grandezza fisica, per la dichiarazione di percentuale di riciclato, come da specifica di vendita (es. pezzo, kg, m²)	Peso netto del prodotto certificato (Kg)	Percentuale complessiva di materiale riciclato contenuto	Codici europei dei rifiuti da cui deriva il materiale riciclato	Descrizione delle componenti contenenti materiale riciclato	Descrizione delle componenti non contenenti materiale riciclato
JOI T6_A	kg	5,91	30,30%	Il materiale utilizzato di riciclo non deriva da un codice rifiuto	Top in ABS	Telaio in acciaio, pannello frontale in ABS
JOI T5_A	kg	5,88	30,50%	Il materiale utilizzato di riciclo non deriva da un codice rifiuto	Top in ABS	Telaio in acciaio, pannello frontale in ABS
JOI T4_A	kg	5,84	30,70%	Il materiale utilizzato di riciclo non deriva da un codice rifiuto	Top in ABS	Telaio in acciaio, pannello frontale in ABS
JOI T3_A	kg	5,81	30,80%	Il materiale utilizzato di riciclo non deriva da un codice rifiuto	Top in ABS	Telaio in acciaio, pannello frontale in ABS

Note

Notes / Note

Pulizia

Per le parti metalliche consigliamo esclusivamente un panno morbido e alcool asciugando bene dopo la pulizia. Per le superfici in plastica, usare panno umido ed acqua con detersivo liquido neutro, non usare solventi, trielina, acetone o ammoniaca.

Cleaning

For the metal parts we recommend only a soft cloth and alcohol, drying well after cleaning. For plastic surfaces, use a damp cloth and water with neutral liquid detergent, do not use solvents, trichlorethylene, acetone or ammonia.

Nettoyage

Pour les parties métalliques, nous recommandons uniquement un chiffon doux et de l'alcool, bien sécher après le nettoyage. Pour les surfaces en plastique, utilisez un chiffon humide et de l'eau avec un détergent liquide neutre, n'utilisez pas de solvants, de trichloréthylène, d'acétone ou d'ammoniac.

Garanzia

I nostri prodotti sono garantiti 5 anni (testo integrale della garanzia su richiesta). Un uso improprio del prodotto preclude la garanzia dello stesso.

Warranty

Our products are guaranteed for 5 years (full text of the guarantee on request). Improper use of the product precludes its warranty.

Garantie

Nos produits sont garantis 5 ans (texte complet de la garantie sur demande). Une mauvaise utilisation du produit exclut sa garantie.

Uso improprio

Non sono consentiti: Modifiche strutturali e/o manomissioni al prodotto.

Improper use

The following are not allowed: Structural changes and / or product tampering.

Utilisation incorrecte

Les éléments suivants ne sont pas autorisés : Modifications structurelles et/ou altération du produit.