

DIVANVM

C O L L E C T I O N

DIVANVM

C O L L E C T I O N

Qualità, Comfort, Design, Tendenza...intramontabili!

La Collezione DIVANVM rappresenta la sintesi delle migliori aspettative nella scelta di un imbottito d'arredo di prestigio, la somma delle caratteristiche ideali nella forma preferita. Ogni modello della Collezione DIVANVM viene realizzato per assecondare i vostri desideri e interpretare magnificamente la scelta più precisa, quella destinata a soddisfare ogni vostra esigenza di gusto e di raffinata personalizzazione degli ambienti.

Quality, Comfort, Design, Trend ... timeless!

The DIVANVM Collection is the synthesis of the best expectations in choosing a prestigious furnishing pad, the sum of the ideal features in the preferred form. Each model of the DIVANVM Collection is designed to fulfill your wishes and to interpret the most accurate choice, the one designed to satisfy your every need for taste and refined personalization of the environments.





INDEX

4. MILANO



10. MILANO



28. LARIO



30. LARIO



26. CAMILLA



50. SQUARE



54. ALICE



56. GINGER



60. NELLA



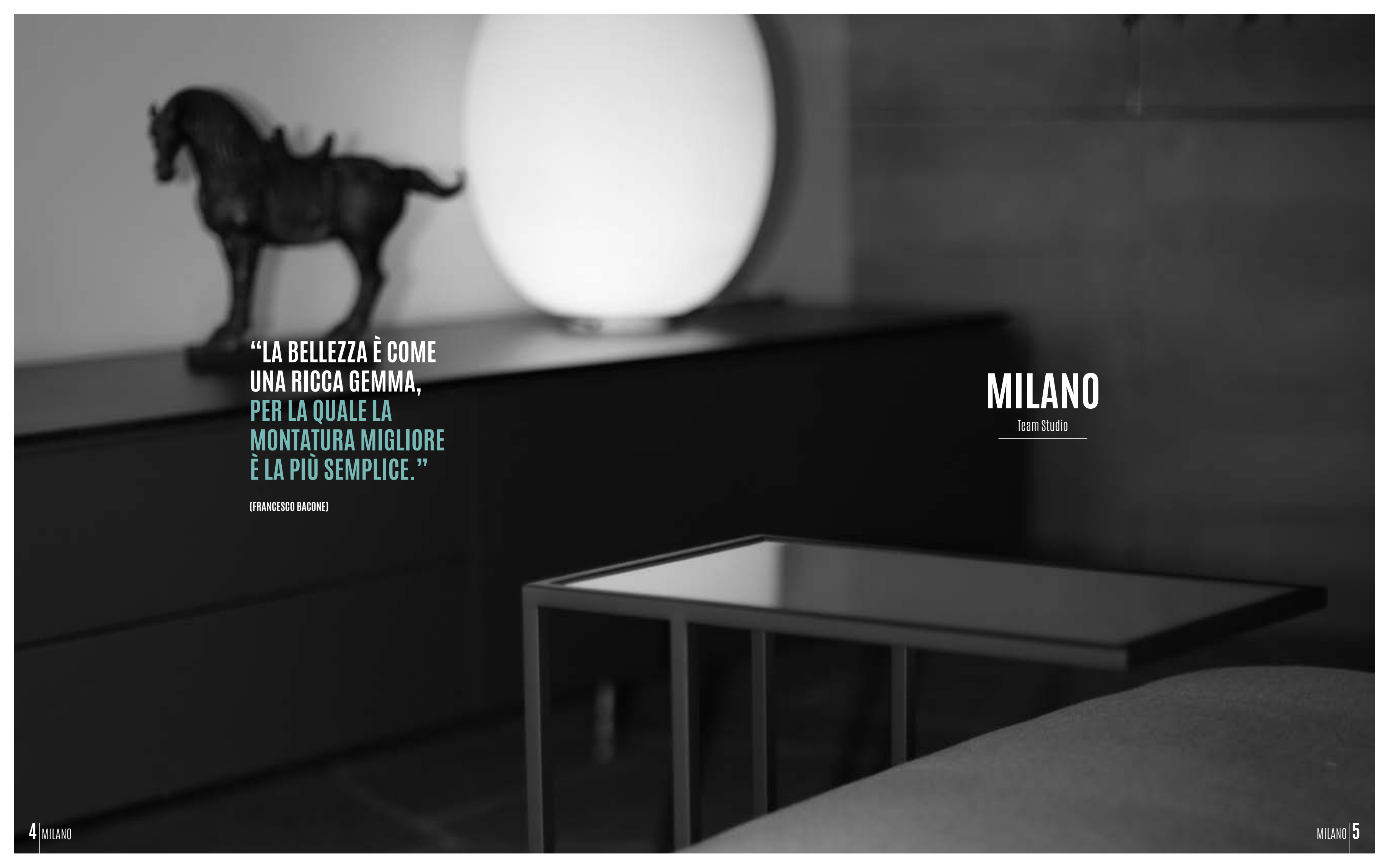

**“LA BELLEZZA È COME
UNA RICCA GEMMA,
PER LA QUALE LA
MONTATURA MIGLIORE
È LA PIÙ SEMPLICE.”**

(FRANCESCO BACONE)

MILANO

Team Studio





SCELTA DEI CUSCINI E POGGIATESTA A PIACERE
PERSONAL CHOICE OF PILLOWS AND HEADREST









DIVANVM
COLLECTION

**ELEMENTO TERMINALE
CON BRACCIOLO O TAVOLINO,
COMFORT E PRATICITÀ**
TERMINAL ELEMENT
WITH ARMREST OR SMALL TABLE
COMFORT AND PRACTICALITY



CONFIGURAZIONE E DISPOSIZIONE
DIVERSE DEGLI ELEMENTI
DIFFERENTE CONFIGURATION
AND DISPOSAL OF ELEMENTS



SOLO A RICHIESTA: ELEMENTO D'APPOGGIO CENTRALE
ONLY REQUEST: APPLICATION OF CENTRAL ELEMENT





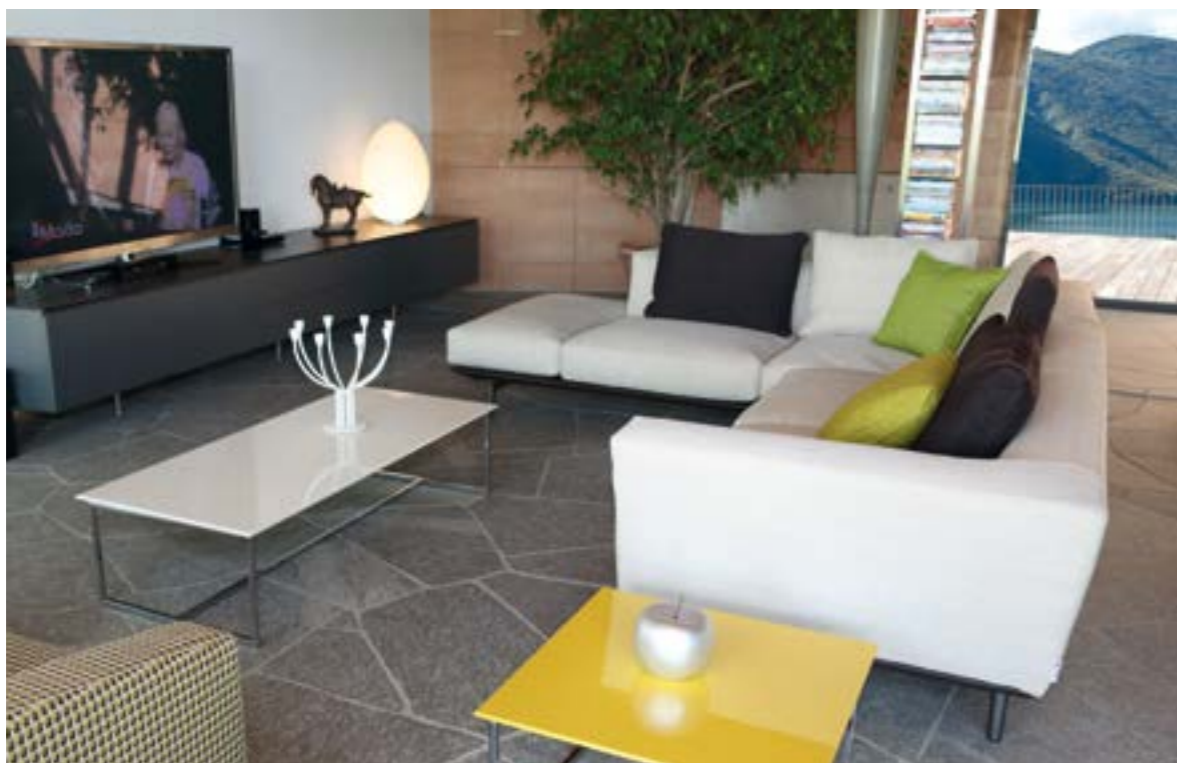

TAVOLINO SQUARE

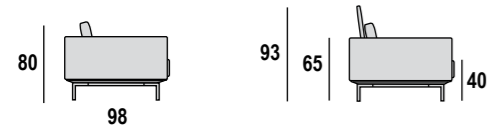

Divani - Sofas

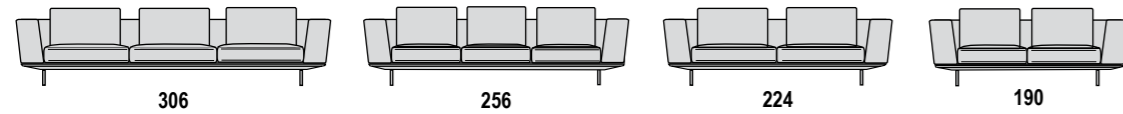

Elementi terminali dx-sx
Terminal elements dx-sx

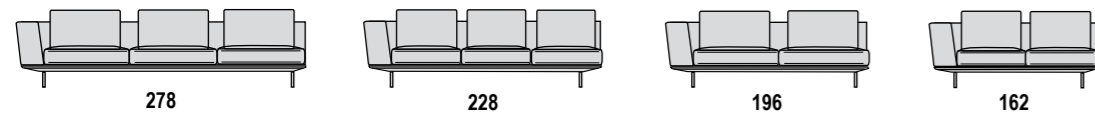

Elementi centrali
Central Elements

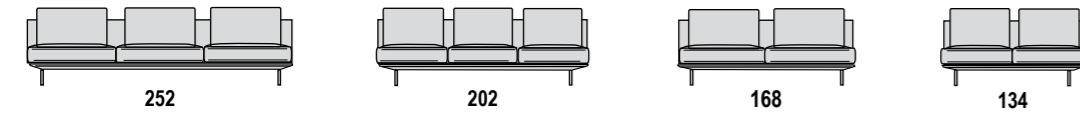

Dormeuse dx-sx

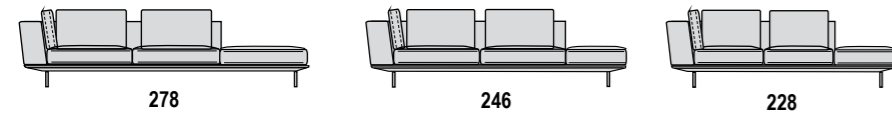

Composizioni a catalogo
Catalog composition

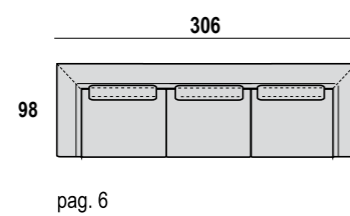
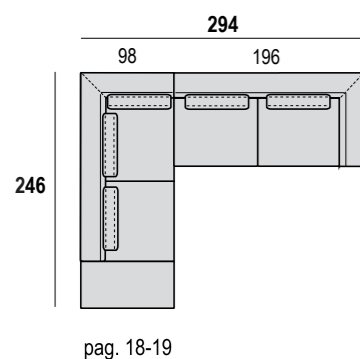
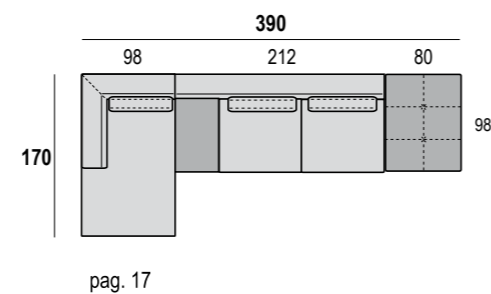
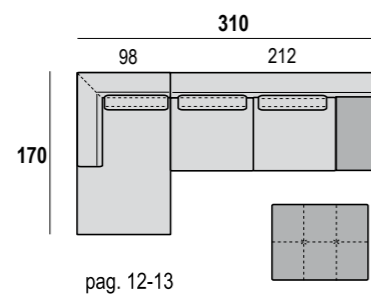
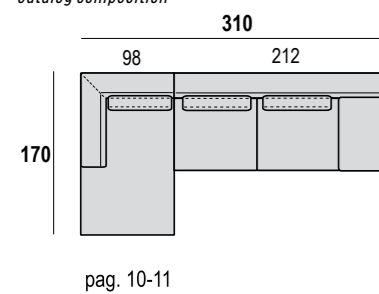

ELEMENTI CON BRACCIOLO A CUSCINO
ELEMENTS WITH ARM-CUSHION LOW

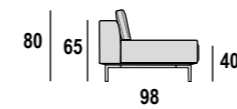

Divani - Sofas

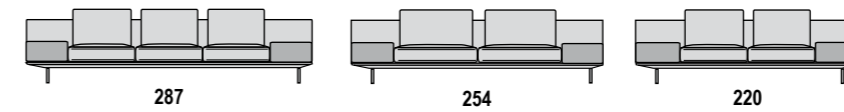

Elementi terminali dx-sx
Terminal elements dx-sx

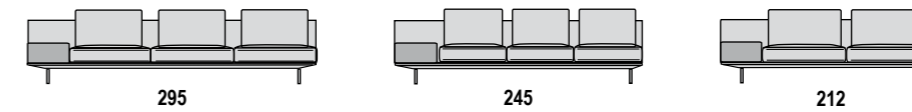

Elementi angolari/terminale cuscino basso dx-sx
Angle/terminal elements dx-sx

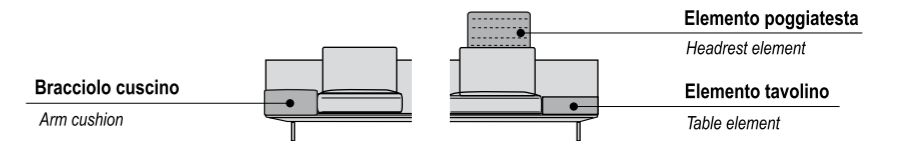
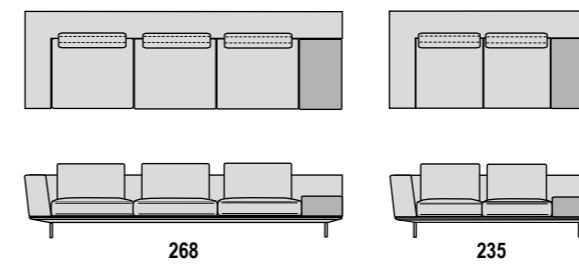

Poggiatesta
Headrest



Tavolino
Table

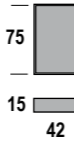

Bracciolo cuscino
Arm cushion

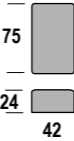

Chaise longue
dx-sx

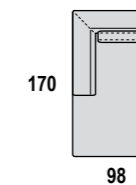

Pouff

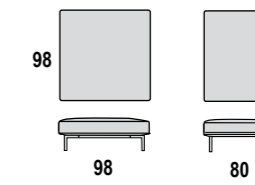

Basamento in metallo rivestito in tessuto o pelle; piano seduta con cinghie elastiche.
Struttura schienale e braccioli in legno multi imbottito in poliuretano espanso e trapuntino in piuma d'oca, rivestito in tela cotone bianca. Alternativa al bracciolo, elemento a cuscinetto in espanso.
Cuscino seduta in piuma d'oca con inserto in espanso indeformabile, reversibile.
Cuscino schienale in piuma d'oca a comparti.
 Completamente sfoderabile, compreso il basamento in metallo rivestito in pelle o tessuto.
Piedini metallo tubolare cromo lucido, satinato, bronzato.
Accessori a richiesta:
 - Cuscinetti in piuma d'oca di dimensioni diverse.
 - Poggiatesta telaio in metallo, rivestimento trapuntato.
 - Tavolino struttura in legno rivestito in pelle o tessuto, con piano appoggio in lamiera a finitura gofrata.
 A richiesta: possibilità di cambiare posizione al tavolino, con predisposizione al telaio per fissaggio.

*Metal base covered in fabric or leather; floor sitting with elastic belts.
 Structure upholstered wood armrests and backrest in expanded polyurethane and quilted goose feather, covered in white linen. Alternative to armrest, an expanded cushion element.
 Cushion sitting in goose feather with a non-deformable foam insert, reversible.
 Back cushion in goose down to compartments.
 Fully removable, including metal or leather upholstered base.
 Feet chromium plated metal, satin, bronzed.
 Optional accessories:
 - Small cushions, goose feathers of different sizes.
 - Headrest, metal chassis headrest, quilted cover.
 - Table, wooden side table in leather or fabric covered with embossed metal sheet top.
 On request: possibility to change position at the table, with attachment to the fixing frame.*



**“IL MIGLIOR AMICO DELL’UOMO
ACCANTO ...AL VOSTRO COMFORT.”**

CAMILLA

design: Studio Creare



Struttura in legno con imbottitura in poliuretano espanso indeformabile e dacron. Cuscino seduta in espanso. Completamente sfoderabile. Piedini o ruote in acciaio.

Frame in solid wood, upholstered with non-deformable polyurethane foam and dacron. Seat cushion in polyurethane foam. Fully removable fabric covers upholstery. Steel feet or wheels.



“DAI A OGNI GIORNATA
LA POSSIBILITÀ DI
ESSERE LA PIÙ BELLA
DELLA TUA VITA.”

(MARK TWAIN)

LARIO

Team Studio









COMPLETAMENTE RIVESTITO CON I TESSUTI DEL VASTO CAMPIONARIO
COMPLETELY COVERED WITH THE FABRICS CHAMPIONSHIP





TAVOLINO SQUARE_CUOIO

Base rivestita o laccata a piacere:
infinite possibilità di accostamenti
di tessuti, laccature, e cuoio.

Different covered or lacquered base:
fabrics, leather or lacquered colors.









DIVANVM
COLLECTION



TESSUTO / FABRIC



LACCATO RAL / RAL LACQUARED

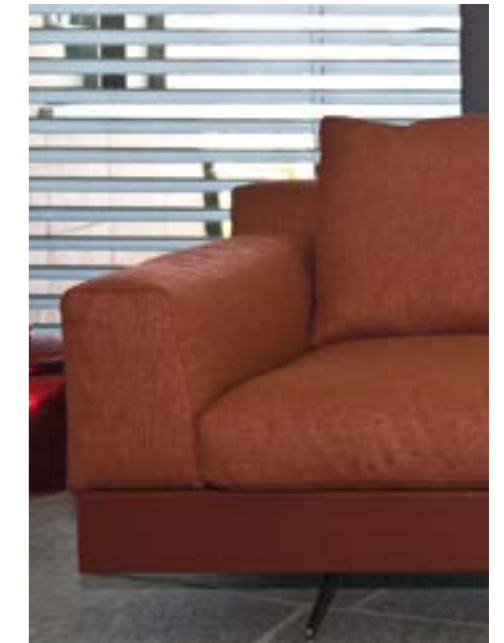

CUOIO / LEATHER

**MATERIALI E COLORI CON
ACCOSTAMENTI A PIACERE**
MATCHING MATERIALS AND
COLORS AS YOU LIKE

Versioni base
Versions base

IMBOTTITA
Padded

LACCATA
Lacquered

CUOIO
Leather

Divani - Sofas

306 - 286 266 - 246 220 206 192 180

Elementi terminali dx-sx
Terminal elements dx-sx

283 - 263 243 - 223 196 183 169 157

Elementi centrali
Central Elements

260 - 240 220 - 200 174 160 146 135

Divano angolare senza bracciolo, con bracciolo dx/sx +23 cm
Angular elements dx/sx without arm, with arm +23cm

283 - 263 243 - 223 196 183 169-157

ELEMENTI ANGOLARI dx-sx - schienale ridotto
Elements Angle dx-sx - reduced back

98 196 87 183 80 170 73 156 67

283 263 243 223

DORMEUSE con cuscineti laterali
Dormeuse with lateral cushions

98 223 183

CHAISE LONGUE

172 98

POUFF

98 98 h.42 98 70

Cuscino poggiatesta
Headrest



BASE: FINITURE ALTERNATIVE
BASE: ALTERNATIVE FINISHES

RAL e PELLE fuori collezione
contattare l'Azienda

RAL and LEATHER extra collection t
o contact the Company

Base laccata, con finitura brillante
lacquered base, with a glossy finish



- Ral 9016 - bianco /white
- Ral 9005 - nero/black
- Ral 7006 - grigio beige /gray beige
- Ral 7044 - grigio seta /grey silk

Base rivestita in cuoio, con cuciture in tinta a vista
Base covered in leather, with seams in the same color (visible)



- BIANCO /White
- TESTA DI MORO /Dark-brown
- ROSSO BULGARO /Reddish-brown
- NERO /Black
- BORDEAUX /Bordeaux

Composizioni a catalogo
Catalog composition

266 341 98 243 223

pag. 30 - 44 pag. 34

246 220

pag. 38 pag. 42

Struttura in legno massello imbottito in poliuretano espanso e fibre acriliche, ricoperta in tela cotone bianca.

Cuscino seduta in piuma d'oca con inserto in espanso indeformabile, reversibile.

Cuscino schienale in piuma d'oca con poggiatesta inserito in miscela di fibre ovoidali. Tutti i cuscini sono rivestiti in tela cotone bianca.

Cuscineti in piuma d'oca di dimensioni diverse.

Piedini metallo cromo lucido, bronzato.

Supplementi a richiesta per finiture basamento
- basamento in MDF laccato finitura brillante
Colori standard RAL: 9016 (bianco) - 9005 (nero) - 7006 (grigio/beige) - 7044 (grigio seta)
- basamento rivestito in cuoio con cuciture a vista in tinta.
Colori standard cuoio: testa di moro, rosso bulgaro, bianco, nero, bordeaux.

Structure in solid wood stuffed with polyurethane foam and acrylic fibers, covered in white cotton cloth.

Cushion sitting in goose feather with a non-deformable foam insert, reversible.

Back cushion in goose feather with backrest embedded in ovoid fiber blend. All cushions are lined with white cotton cloth.

Small cushions, goose feathers of different sizes.

Feet, chromium-plated metal, bronzed.

Supplements on request for stand finishes
- glossy lacquered MDF base
Standard colors RAL: 9016 (white) - 9005 (black) - 7006 (gray / beige) - 7044 (gray silk)
- leather upholstered base with seamless stitching.
Standard leather colors: dark brown, red bulgarian, white, black, bordeaux.

“LA FELICITÀ
È AMORE, NIENT'ALTRO.”

(HERMANN HESSE)

SQUARE

design: Arch. A. Mandelli, W. Selva

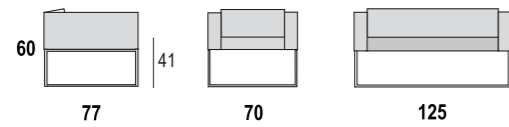

Poltroncina - Struttura base in tubolare d'acciaio a sezione quadra, cromato lucido. Struttura seduta in legno rivestita in poliuretano espanso indeformabile e fibre acriliche. Non sfoderabile.

Armchair - Glossy chrome-plate, square section tubular steel frame. Solid wood seat upholstered with polyurethane foam covered by acrylic padding. Non-removable cover.

piano legno o cuoio
Wooden or Leather Top

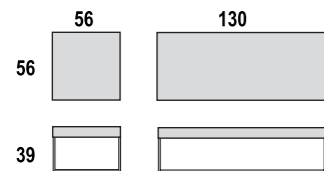

piano laccato brillante
glossy lacquered top

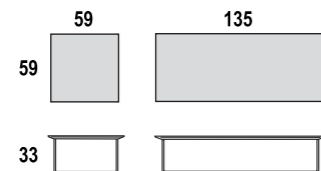

Tavolini - Struttura base in tubolare metallo a sezione quadra, cromato lucido. Soluzioni diverse per il piano: legno tinto wengè, rovere sbiancato, ciliegio, bianco; MDF rivestito in vero cuoio nei colori della collezione e cuciture filo a vista in tinta; Top in MDF laccato finitura brillante, nei colori RAL in collezione.

Coffee tables - Frame in square tubular metal tube, polished chrome. Different solutions for the plan: wengè dyed wood, bleached oak, cherry, white; MDF covered in real leather in the colors of the collection and thread stitching in the same color; Top in MDF lacquered brilliant finish, in RAL colors in collection





ALICE

design: Arch. A. Mandelli

**LA POLTRONA MODERNA
DAL DESIGN PULITO E
ACCATTIVANTE**
**THE MODERN ARMCHAIR
FROM DESIGN CLEANED AND
ACCERTING**

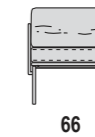
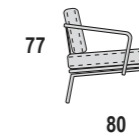

Struttura a vista in acciaio cromato. Su richiesta, rivestimento braccioli in cuoio. Cuscini seduta e schienale in piuma d'oca, sfoderabili.

Load-bearing frame in glossy chrome-plated tubular steel. Arms available on demand in natural thick leather. Seat and back cushion in sterilized goose feather.





**"SI USANO GLI SPECCHI
PER GUARDARSI IL VISO,
E SI USA L'ARTE
PER GUARDARSI L'ANIMA.**

(GEORGE BERNARD SHAW)

GINGER-NELLA

design: Arch. A. Mandelli, W. Selva



NELLA

design: Arch. A. Mandelli, W. Selva



GINGER

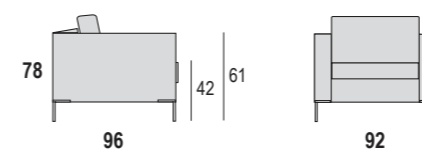

Struttura in legno massello. Imbottitura in poliuretano espanso rivestito con fibre acriliche. Cuscino schienale in piuma d'oca sterilizzata con inserto in poliuretano espanso; cuscino seduta in poliuretano espanso a quote differenziate e rivestito con fibre acriliche. Rivestimento completamente sfoderabile. Piede cromato lucido.

Frame in solid wood, upholstered with polyurethane foam covered by acrylic padding. Back cushions in sterilized goose feather with polyurethane foam inner support. Seat cushion in differentiated-density polyurethane foam, covered by acrylic padding. Fully removable fabric covers. Glossy chrome-plated feet.

NELLA

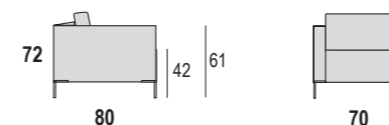

Struttura in legno massello con imbottitura in poliuretano espanso rivestito con fibre acriliche. Cuscino schienale in piuma d'oca sterilizzata; cuscino seduta a corpo unico in poliuretano espanso a quote differenziate e dacron. Rivestimento completamente sfoderabile. Piedini acciaio cromato.

Frame in solid wood, upholstered with polyurethane foam covered by acrylic padding. Back cushions in sterilized goose feather; seat cushion in differentiated-density polyurethane foam and Dacron. Fully removable fabric covers or natural leather upholstery. Chrome-plated steel feet.

www.citteriomedait



DIVANVM
COLLECTION

Via Tagliamento 23, angolo via Laguna - 20821 MEDA (MB)
Tel.: +39 0362 340386 | +39 0362 71744 - Fax: +39 0362 340389 - mail: info@citteriomedait

